

Preparation

Part Number: Fit Kit PT545-35090

Tuner Assy: PT545-00080

NOTE: Part number of this accessory may not be the same as the part number shown.

Tuner Assy Kit Contents (PT545-00080)

Item #	Quantity Reqd.	Description
1		Tuner Assy, Stereo Component

Mounting Kit Contents (PT545-35090)

Item #	Quantity Reqd.	Description
1	1	Wire Harness
2	1	Antenna Bag
3	3	Hardware Bags
4	1	Owner's Manual

Hardware Bag Contents - 1

Item #	Quantity Reqd.	Description
1	9	Cable Tie
2	6	Foam Pad Sheet
3	4	Double-sided Tape 0.5" x 3.5"

Hardware Bag Contents - 2

Item #	Quantity Reqd.	Description
1	2	Aluminum Foil Pads
2	2	Foam Pad
3	2	Double-sided Tape 0.5" x 3.5"

Hardware Bag Contents - 3

Item #	Quantity Reqd.	Description
1	6	Cable Tie

Antenna Bag Contents – 1 (PT545-42095-EA)

Item #	Quantity Reqd.	Description
1	1	Antenna
2	1	Connector Housing
3	1	Cable Cover
4	1	Cable Cover Adhesive
5	1	Alcohol Wipe

Conflicts

XM Satellite Radio
Interface Kit for iPod

Recommended Tools

Personal & Vehicle Protection	Notes
Safety Goggles	
Seat Protectors	
Floor Protectors	
Protective Tape	Masking Tape
Protective Blanket	
Special Tools	Notes
None	
Installation Tools	Notes
Ratchet	
Extensions	
Sockets	8mm, 10mm, 14mm

Torque Wrench	4 N•m (3 ft-lbf), 36 N•m (27 ft-lbf)
Screwdriver	#2 Phillips
Nylon Removal Tool	e.g. Panel Pry Tool #1 Toyota SST # 00002-06001-0
Needle Nose Pliers	
Special Chemicals	Notes
Cleaner	3M™ Prep Sol-70
Cleaner	Approved Cleaner or house hold glass cleaner
Body Sealant	

General Applicability

--

Recommended Sequence of Application







Item #	Accessory
1	
2	
3	

*Mandatory

Vehicle Service Parts (may be required for reassembly)

Item #	Quantity Reqd.	Description
1		
2		
3		

Legend

	STOP: Damage to the vehicle may occur. Do not proceed until process has been complied with.
	OPERATOR SAFETY: Use caution to avoid risk of injury.
	CAUTION: A process that must be carefully observed in order to reduce the risk of damage to the accessory/vehicle and to ensure a quality installation.
	TOOLS & EQUIPMENT: Used in Figures calls out the specific tools and equipment recommended for this process.
	REVISION MARK: This mark highlights a change in installation with respect to previous issue.
	SAFETY TORQUE: This mark indicates that torque is related to safety.

Parts Description of Tuner Assy (PT545-00080)

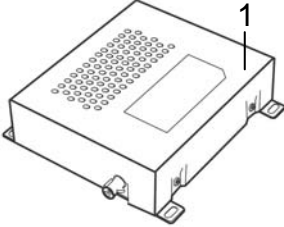

Item #	Part Name	Part No.	Qty
1	Tuner	PT545-00080	1

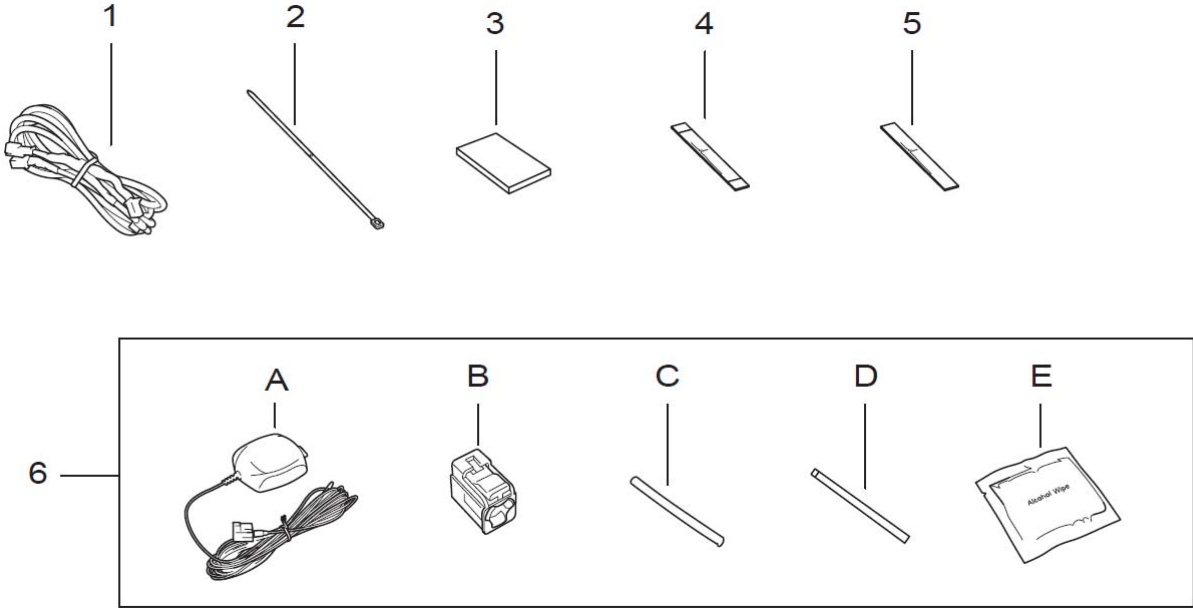

Parts Description of Mounting Kit (PT545-35090)

Item #	Part Name	Qty
1	Wire, To Radio Installation	1
2	Cable Tie	15
3	Foam Pad	8
4	Double-sided Tape 0.5" x 3.5"	6
5	Aluminum Foil Pad	2
6	A Antenna	1
	B Connector Housing	1
	C Cable Cover	1
	D Cable Cover Adhesive	1
	E Alcohol Wipe	1

Procedure

Care must be taken when installing this accessory to ensure damage does not occur to the vehicle. The installation of this accessory should follow approved guidelines to ensure a quality installation.

These guidelines can be found in the "Accessory Installation Practices" document.

This document covers such items as:

- Vehicle Protection (use of covers and blankets, cleaning chemicals, etc.).
- Safety (eye protection, rechecking torque procedure, etc.).
- Vehicle Disassembly/Reassembly (panel removal, part storage, etc.).
- Electrical Component Disassembly/Reassembly (battery disconnection, connector removal, etc.).

Please see your Toyota dealer for a copy of this document.

1. Vehicle Protection

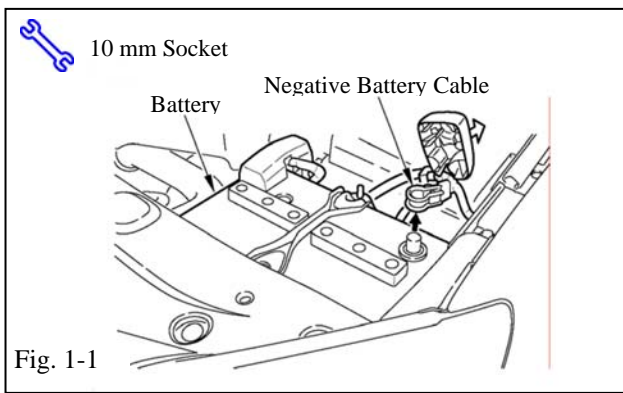

- (a) Place driver seat in mid position.
- (b) Set emergency brake.
- (c) Remove the negative battery cable. (Fig. 1-1)



- (1) Protect the fender before starting.



CAUTION: Do not touch the positive terminal with any tool when removing cable.



- (d) Using protective blankets cover front seats, interior of vehicle and center console and front side of the shift lever.

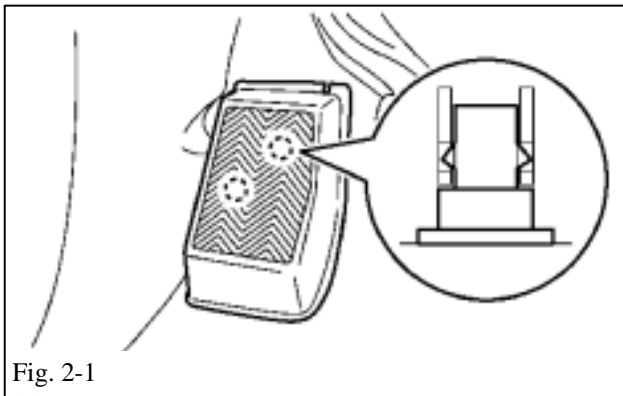

- (e) Wait 90 seconds before proceeding to disassemble vehicle.

2. Disassembly of Vehicle

- (a) Remove front floor footrest.

For Access Cab

- (1) Disengage the two (2) clips and remove the front floor footrest. (Fig. 2-1)

- (b) Remove front door scuff plate LH.

For Access Cab

- (1) Disengage the nine (9) claws and clip, and remove the front door scuff plate. (Fig. 2-2)

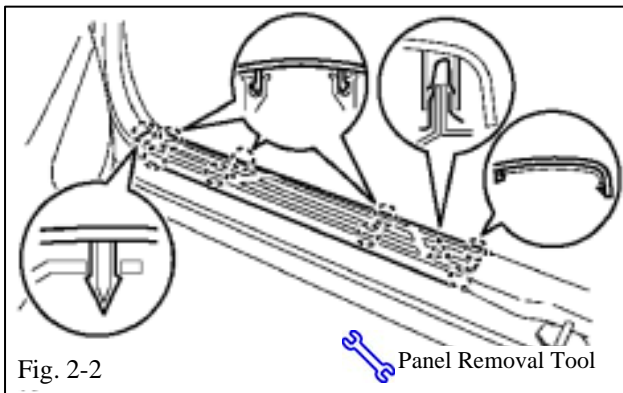

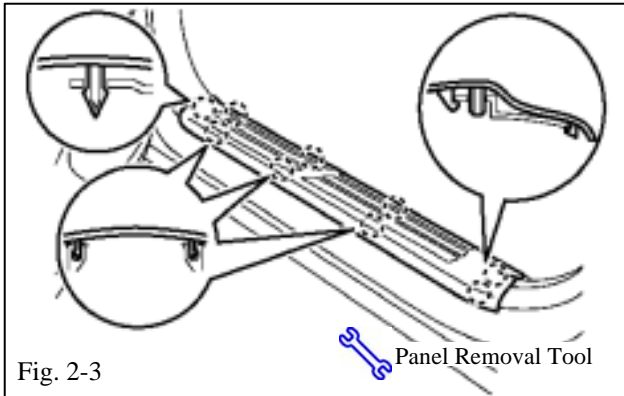

For Double Cab

- (2) Disengage the nine (9) claws and remove the front door scuff plate. (Fig. 2-3)

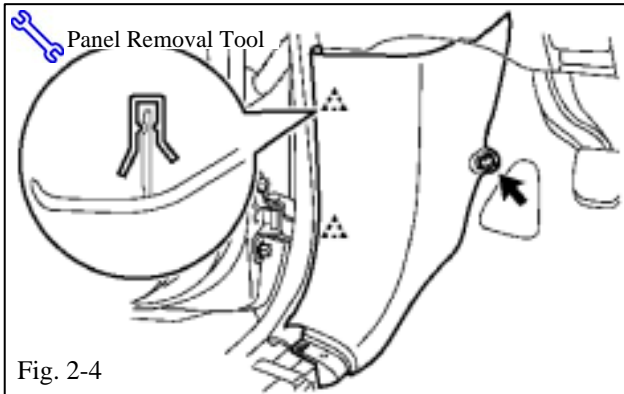

- (c) Remove cowl side trim board LH.

For Access Cab

- (1) Remove the clip. (Fig. 2-4)

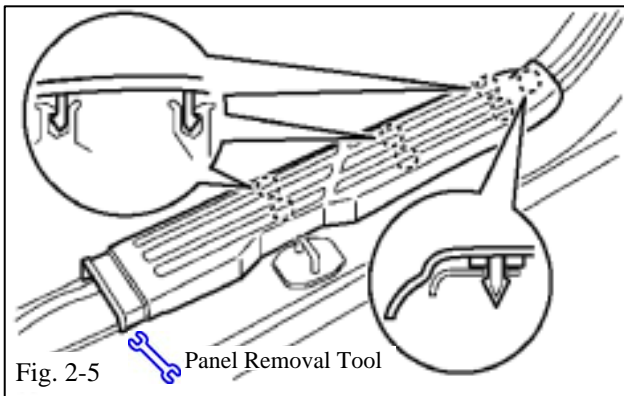

- (d) Remove rear door scuff plate LH.

For Access Cab

- (1) Disengage the seven (7) claws and remove the rear door scuff plate. (Fig. 2-5)

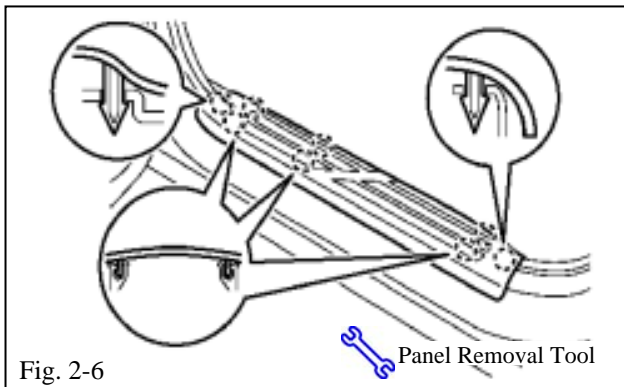

For Double Cab

- (2) Disengage the eight (8) claws and remove the rear door scuff plate. (Fig. 2-6)

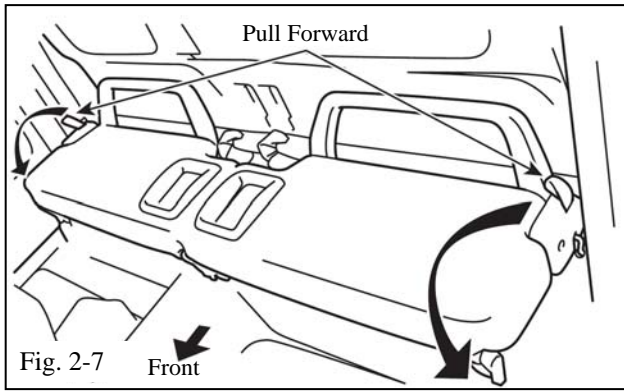

(e) Remove rear seat.

(1) Pull rear seat forward by pulling rear seat cushion band. (Fig. 2-7)

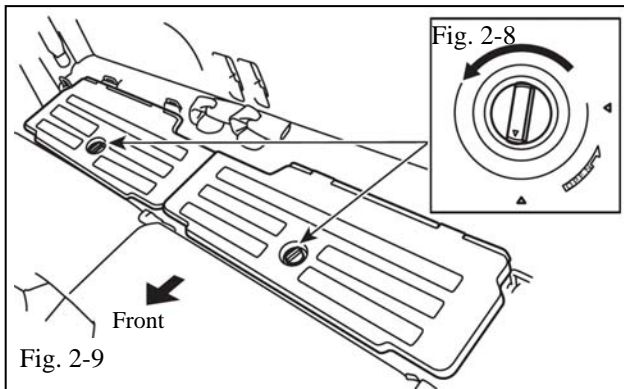

(2) Open the bottom rear seat compartment by unscrewing the locks. (Fig. 2-8 & 2-9)

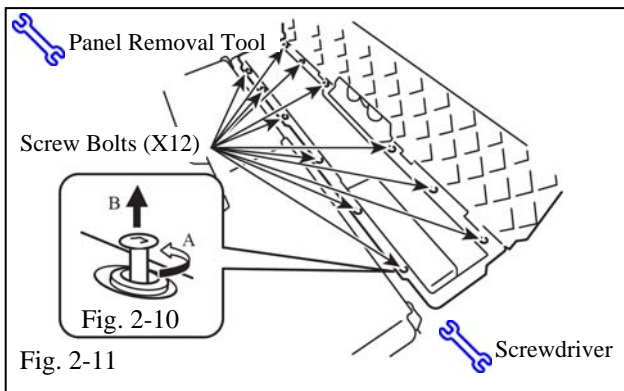

(f) Remove bottom rear seat storage compartment by detaching the twelve (12) screws. (Fig. 2-10 & 2-11)

(1) Unscrew the screw.
(2) Using panel removal tool, pull out screw.

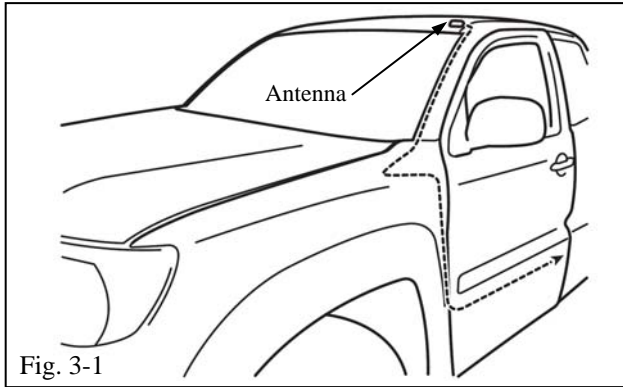

Fig. 3-1

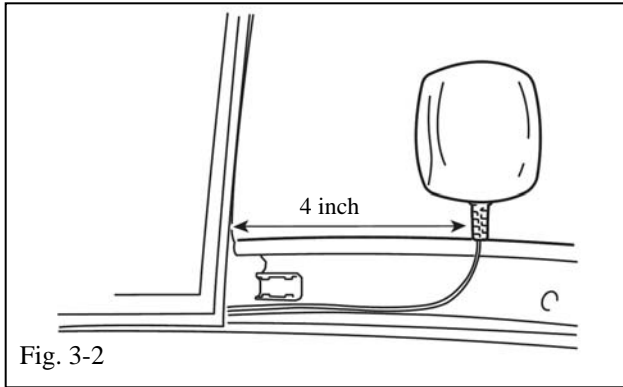

Fig. 3-2

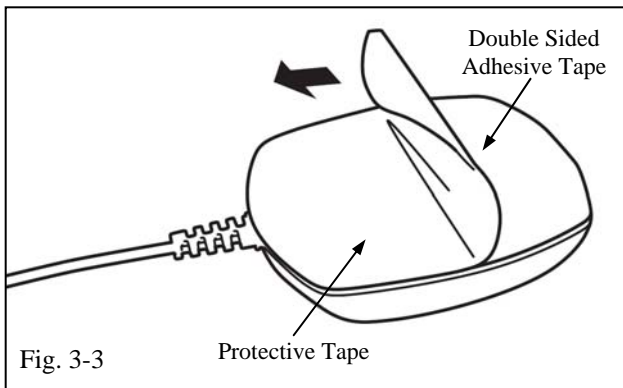

Fig. 3-3

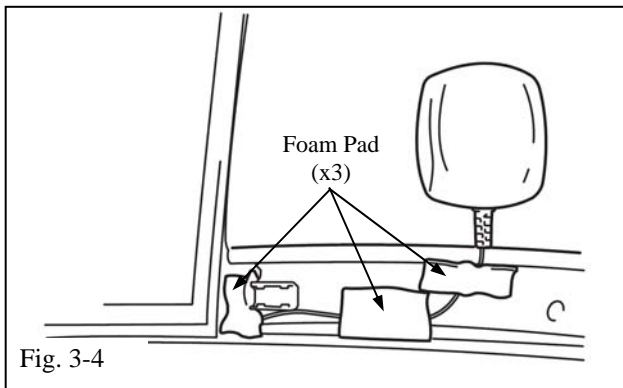

Fig. 3-4

3. Installing and Routing External Antenna

Antenna installation and wiring should be performed as shown through the following steps. (Fig. 3-1)

- (a) Clean the antenna mounting area with 3M™ Prep Sol-70.
Prep Sol-70.

NOTE: When cleaning with 3M™ Prep Sol-70.

- (1) Always use a clean (lint free and scratch resistant) soft cloth (or wipe), and clean a small area at a time. (~1ft. x 1 ft. max.)
- (2) Apply 3M™ Prep Sol-70 to cloth or wipe. Do not spray cleaning solution directly on any vehicle surfaces.
- (3) Clean surface thoroughly and wipe dry immediately with a new clean cloth. Do not allow cleaner to air dry.

- (b) Temporarily place the antenna in the position as shown to confirm the installation position. (Fig. 3-2)

- (c) Lift the roof drip side finish molding. (Fig. 3-2)

- (d) Remove the protective tape from the antenna and install the antenna 4 inches from the roof rail side as shown. (Fig. 3-2 & 3-3)

- (1) Cut one (1) piece of foam pad into three (3) pieces and use to secure antenna cable. (Fig. 3-4)

- (e) Secure the antenna cable along the outer edge of the front windshield weather strip using

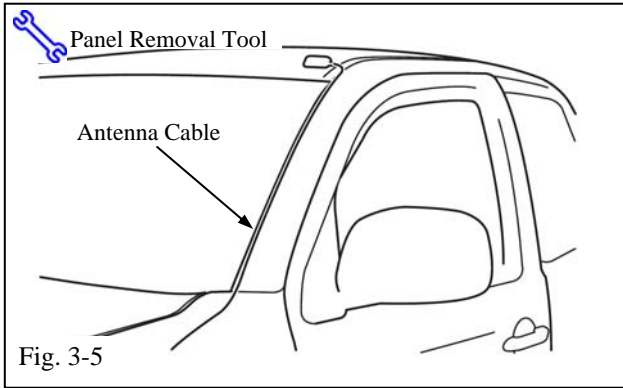

the panel removal tool or similar tool.
(Fig. 3-5)

NOTE: Ensure the antenna cable is placed all the way behind the weather strip.

NOTE: Check to ensure there are no gaps between the weather strip and the windshield.

(f) Route the antenna cable from the bottom of the weather strip as shown toward the outside of the hood hinge. (Fig. 3-5)

(g) Secure the antenna cable.

(1) Clean sheet tape mounting area with 3M™ Prep Sol-70.

(2) Cut one (1) piece of foam pad into three (3) pieces and use to secure antenna cable. (Fig. 3-6)

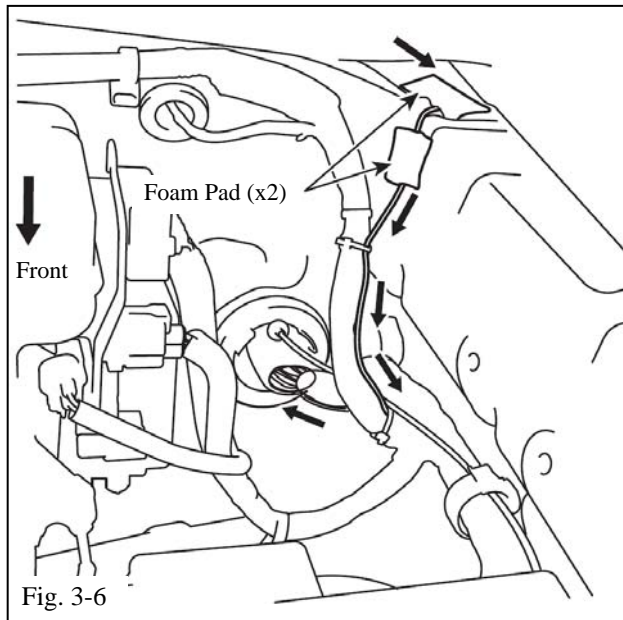

(h) Locate the nipple in the grommet, then cut off the tip of the grommet's nipple. (Fig. 3-7)

(1) Cut off only the tip.

(2) Do not cut the vehicle harness.

NOTE: Use soapy water as lubricant for the following steps as the antenna cable is routed through the grommet into the cabin.

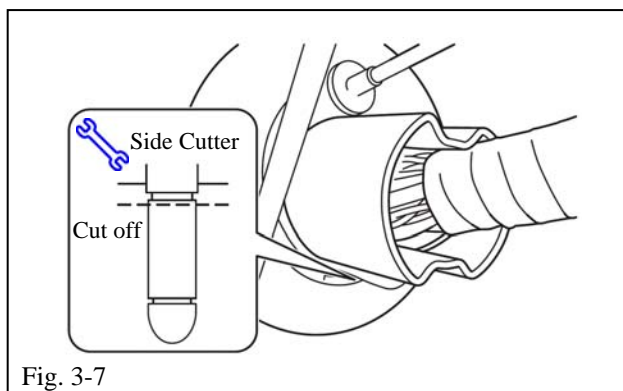

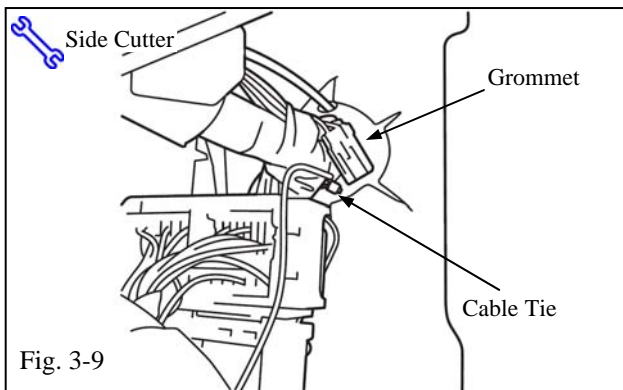
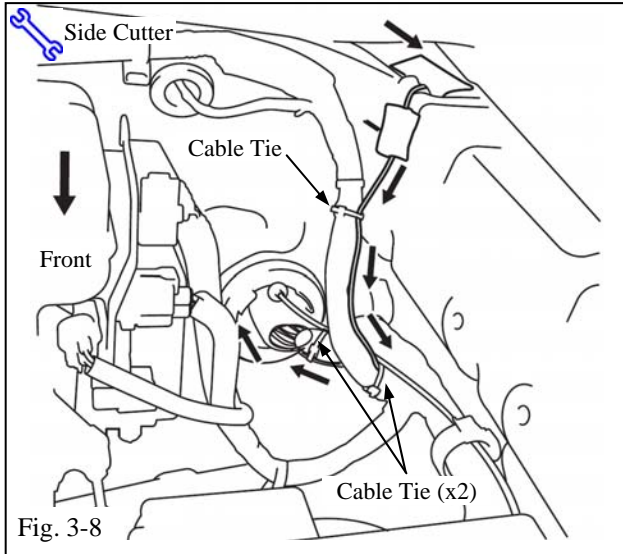

- (i) Insert the antenna cable terminal into the cut nipple of the grommet. (Fig. 3-8)
 - (1) Pull the antenna cable into the cabin.
- (j) Prevent against water intrusion into the cabin.
 - (1) Pull a small length of the antenna cable back into the engine compartment and define the position to secure, ensuring enough slack in the antenna cable as shown. (Fig. 3-8)

NOTE: Be careful not to pull the antenna cable terminal back into the engine compartment.

- (2) Apply the body sealant to the outside of the rubber grommet and the antenna cable at the securing position, then reinsert the antenna cable into the grommet.
- (3) Apply more body sealant from the outside to make the grommet hole air and water tight.
- (4) Secure the antenna cable to the vehicle wiring harness in front of the grommet with a cable tie. (Fig. 3-8)
- (5) Use two (2) more cable ties to secure antenna to vehicle wiring harness inside the engine compartment. (Fig. 3-8)
- (6) Trim excess length from the cable tie after tightening.
- (k) Route the antenna cable through the vehicle cabin.
 - (1) Secure the antenna cable to the vehicle wiring harness along the side body panel with a cable tie. (Fig. 3-9)

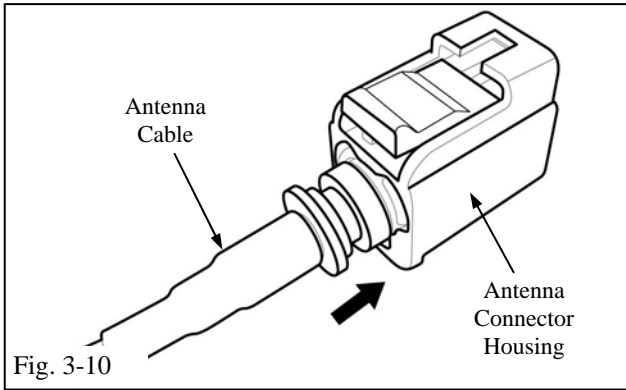

(2) Trim excess length from the cable tie after tightening.

(1) Plug the antenna connector housing into the antenna cable. (Fig. 3-10)

4. Installing the Receiver Harness

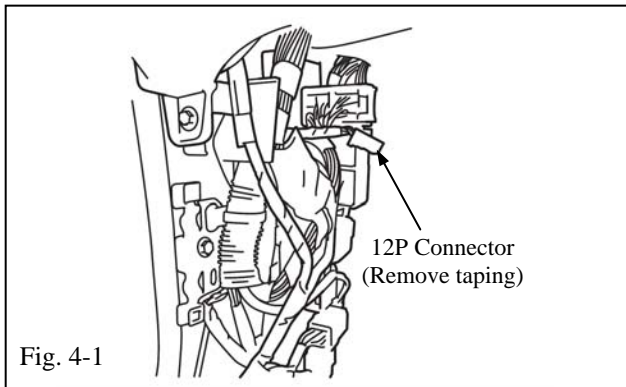

(a) Inside the LH cowl side trim board, locate and remove the 12P connector that is secured to the vehicle wire harness with tape. (Fig. 4-1)

(b) Connect the receiver harness connector. (Fig. 4-2)

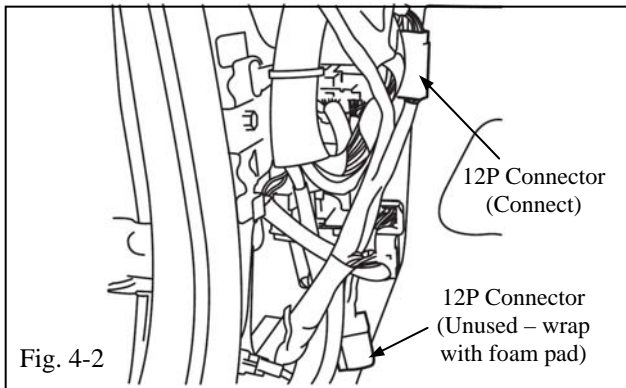

(c) Wrap foam pad around unused connector so it does not rattle.

(d) Run the receiver harness to the rear of the vehicle.

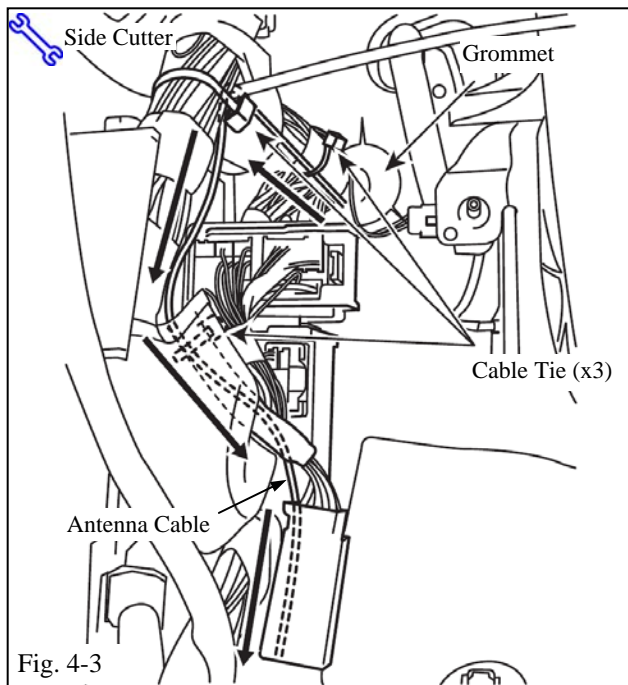

Route the antenna cable from the grommet. (Fig. 4-3 & 4-4)

(e) Secure antenna cable to vehicle wire harness and receiver harness using five (5) cable ties.

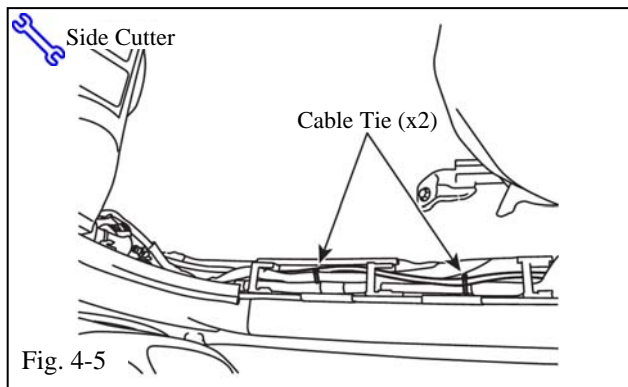
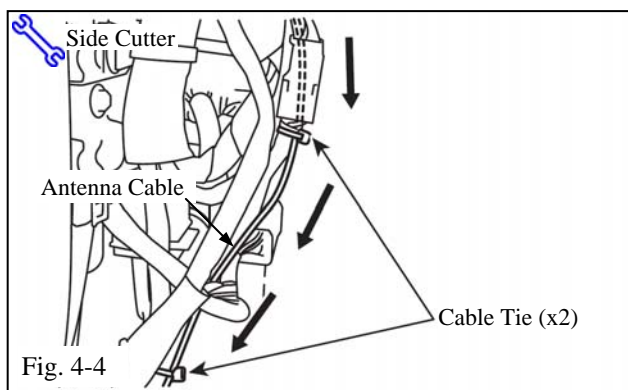

(f) Route receiver harness and antenna cable to rear of vehicle. (Fig. 4-5)

(1) Secure with two (2) cable ties.

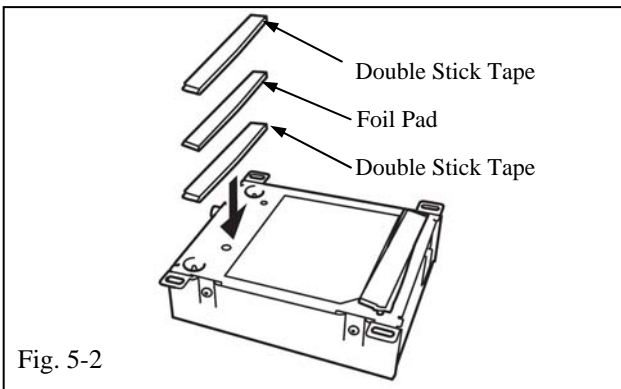
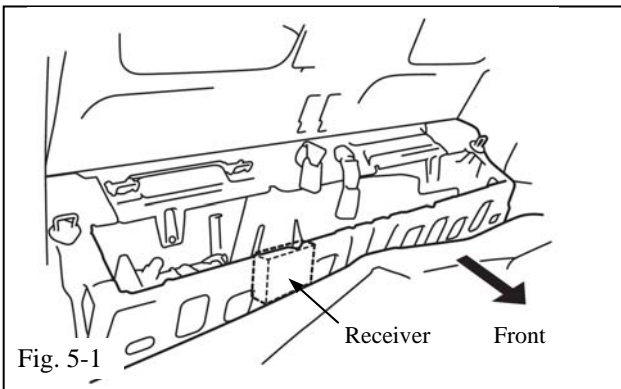
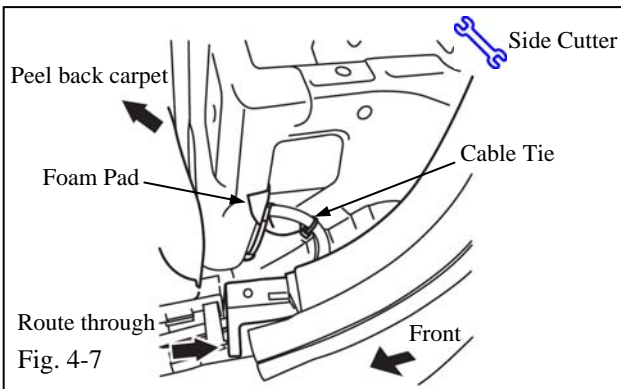
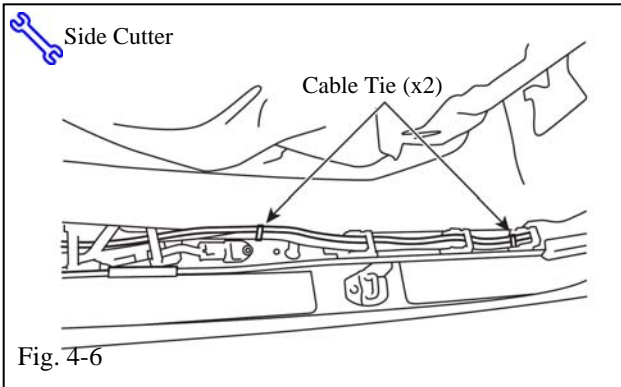

(g) Route receiver harness and antenna cable to rear seat. (Fig. 4-6)

(1) Secure with two (2) cable ties.

(h) Route receiver harness and antenna cable to rear seat storage compartment. (Fig. 4-7)

(1) Pull back carpet.

(2) Route receiver harness and antenna cable underneath bottom of rear quarter trim lower panel and through inside of rear seat storage compartment.

(3) Protect receiver harness and antenna cable with foam pad on edge of rear seat storage compartment entrance.

(4) Secure receiver harness and antenna cable with a cable tie.

5. Installing the Receiver

(a) Clean the receiver mounting location with approved cleaner.

(1) Mount the receiver on the inside wall of the rear seat storage compartment. (Fig. 5-1)

(b) Clean the bottom of the receiver with an approved cleaner.

(c) On each side of the receiver, stack two (2) pieces of double stick tape on top of each other, using the foil pad in between. (Fig. 5-2)

(d) Mount the receiver on the inside wall of the rear seat storage compartment.

(1) Make sure the double side tape touches the wall firmly.

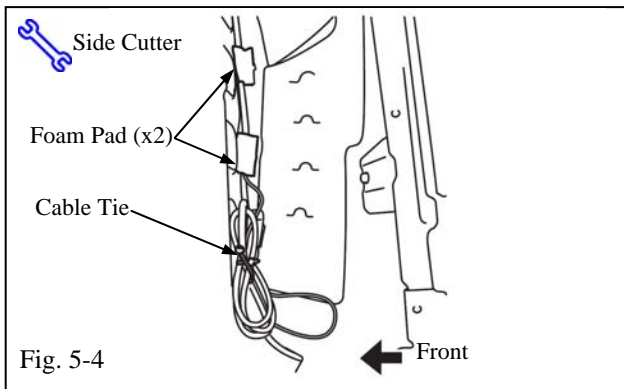
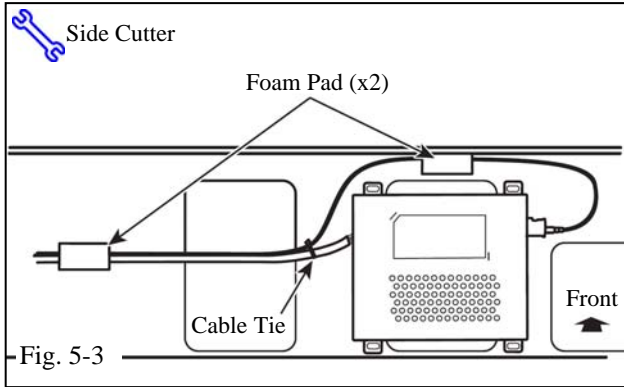

- (2) Firmly apply pressure to the bracket on the wall.
- (e) Plug the connector and antenna into the receiver module.
 - (1) Secure the receiver harness with foam pad. (Fig. 5-3)
 - (2) Secure the receiver harness and antenna cable with a cable tie.
- (f) Bundle access receiver harness and antenna cable and cable tie to wall of rear seat storage compartment. (Fig. 5-4)
- (g) Secure receiver harness using two (2) pieces of foam pad. (Fig. 5-4)



NOTE: Clip all cable ties after tightening.

6. In Process Function Test





- (a) Temporary reconnect battery negative cable.
- (b) Turn ignition key to ACC position.
- (c) Press the power button on the receiver/player head unit. Verify the backlight illuminates.
- (d) Press and release the "SAT" button on the head unit.
- (e) Verify that a satellite channel is received, or a "NO SIGNAL" message appears on the display.

NOTE: If "ANTENNA" appears (flashing) on the display - then the antenna cables are disconnected from the satellite tuner.

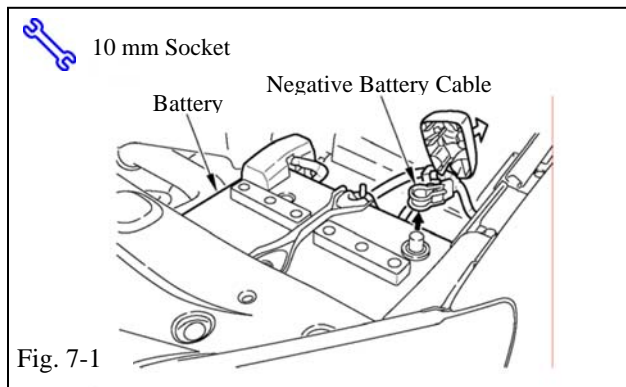
NOTE: If the head unit will not tune or go into satellite mode - then the tuner cable is disconnected from the satellite tuner.



7. Completing the Reassembly of the Vehicle

- (a) Reinstall rear seat storage compartment.
- (b) Reinstall trim pieces.
 - (1) Reconnect any disconnected connectors.
- (c) Reinstall side cowl trim.
- (d) Reinstall door scuff plate.
- (e) Reconnect the vehicle's negative battery cable. (Fig. 7-1)
 - (1) Reconnect the negative terminal back to its original position.
 -  (2) Tighten the nut with 4.1 N-m (36 in-lbf) of torque.
 -  (3) Be careful not to touch the positive battery terminal.
- (f) Clean up and remove any trash.
-  (g) Place the owner's manual in the glove box.

TOYOTA TACOMA 2009 - SIRIUS SATELLITE RADIO TUNER
Checklist - these points **MUST** be checked to ensure a quality installation.

<u>Check:</u>	<u>Look For:</u>
<p><u>Accessory Function Checks</u></p> <p><input type="checkbox"/> Satellite radio tuner</p> <p><input type="checkbox"/> Receiver/player assembly</p>	<p>*Verify the proper operation of the satellite radio tuner.</p> <p>*Verify the proper operation of the receiver/player assembly.</p> <p>*Verify both AM & FM have good reception.</p> <p>*(Refer to the receiver assembly and radio owner's manuals.)</p>
<p><u>Vehicle Function Checks</u></p> <p><input type="checkbox"/> Hazard switch</p> <p><input type="checkbox"/> HVAC</p> <p><input type="checkbox"/> Multi-information displays (Clock, Temp., and MPG meter)</p> <p><input type="checkbox"/> Operation of the 12V outlet switch</p> <p><input type="checkbox"/> Aux input jack</p>	<p>Verify the proper operation of the hazard switch.</p> <p>Verify the proper operation of the air conditioning system.</p> <p>Verify the proper operation of the 12V outlet switch.</p> <p>Verify the auxiliary input jack is working properly</p>